

Coumar

Chariot avec 2 paniers à main



MODÈLE - AC-EX260

DIMENSIONS

585 x 500 x 1040mm

LONGUEUR : 23po

LARGEUR : 19³/₄po

HAUTEUR : 41po

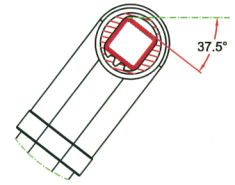
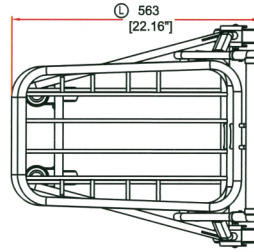
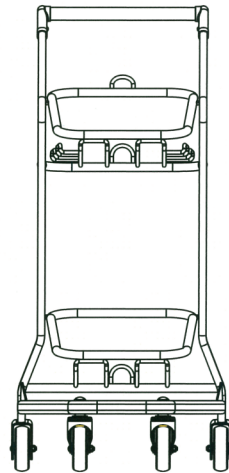
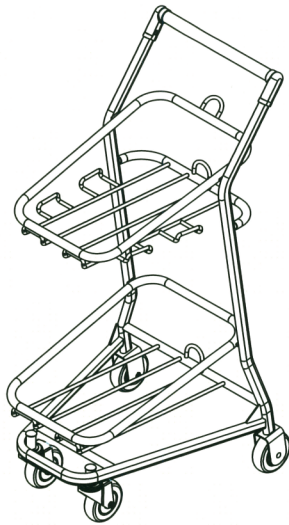

VIEW "A"

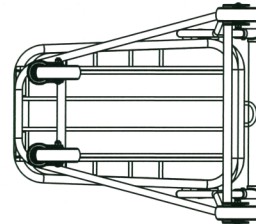
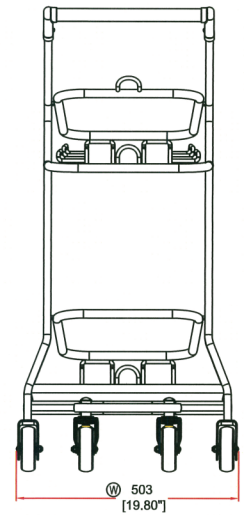
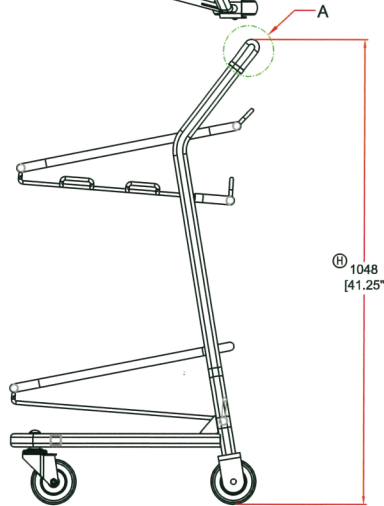

Distributeur

Les Agences Coumar

1028, boul. Sir-Wilfrid-Laurier, Mont-Saint-Hilaire, QC J3H 6A3
Téléphones : 514 912-7676 | 450 536-9006